



# GAMMA PRODOTTI 2018



# LINEA RESIDENZIALE MONOSPLIT





## SILENTIUM

## ENERGY

## NEW COMFORT



## MINI APPLE PIE

## ECO NEW EASY



# GAMMA 2018



SERIE	2.0 kW (Multi)	2.5 kW	3.5 kW	5.0 kW	7.0 kW	
Silentium						Univ
Energy						Univ
New Comfort						Univ
Mini Apple Pie						Univ (Fuori catalogo)
Eco New Easy						Mono (Fuori catalogo)



# SILENTIUM



## TECNOLOGIA

- Valvola di espansione elettronica
- Unità universale
- Moving panel

## PRATICITA'

- Controllo WiFi
- Display LED
- Timer 24h
- Controllo cablato (opz) **NEW**
- Contatto on/off **NEW**

## COMFORT

- 16.5 dB(A)
- Regolazione auto flusso aria
- Super Cooling
- Riavvio 8°C
- I Feel
- Riscaldamento -20°C
- Funzione Sleep
- Funzione SMART

## BENESSERE

- 4 filtri in 1
- Antimuffa
- Filtro ai carboni

## GARANZIA



3 anni prodotto +  
5 anni compressore

## EFFICIENZA

kW	Classe	65%
2,5	A+++/A+++	SI
3,5	A+++/A++	SI
5,0	-	-
7,0	-	-



# ENERGY



## TECNOLOGIA

- Valvola di espansione elettronica
- Unità universale

## COMFORT

- 19 dB(A)
- Regolazione auto flusso aria
- Super Cooling
- Riavvio 8°C
- I Feel
- Riscaldamento -20°C
- Funzione Sleep
- Funzione SMART

## GARANZIA



3 anni prodotto +  
5 anni compressore

## PRATICITA'

- Controllo WiFi
- Display LED
- Timer 24h
- Controllo cablato (opz) **NEW**
- Contatto on/off **NEW**

## BENESSERE

- 4 filtri in 1
- Antimuffa
- Filtro ai carboni

## EFFICIENZA

kW	Classe	65%
2,5	A+++/A++	SI
3,5	A+++/A++	SI
5,0 <b>NEW</b>	A++/A++	SI
7,0 <b>NEW</b>	A++/A++	NO

# NEW COMFORT



## TECNOLOGIA

- Valvola di espansione elettronica
- Unità universale

## PRATICITA'

- Easy Installation
- Controllo WiFi (opz.)
- Display LED
- Timer 24h
- Controllo cablato (opz.)
- Contatto on/off

## COMFORT

- 19 dB(A)
- Regolazione auto flusso <sup>NEW</sup>aria
- Super Cooling
- Riavvio 8°C
- I Feel
- Riscaldamento -15°C
- Funzione Sleep
- Funzione SMART

## BENESSERE

- 4 fitri in 1
- Antimuffa
- Filtro ai carboni

## GARANZIA



3 anni prodotto +  
5 anni compressore

## EFFICIENZA

kW	Classe	65%
2,5	A++/A+	SI
3,5	A++/A+	SI
5,0	A++/A+	NO
7,0	A++/A+	NO





# MINI APPLE PIE



1. SOLO SU PROGRAMMAZIONE
2. RITIRO CONTAINER
3. CONSEGNA A 70GG

## COMFORT

- 19 dB(A)
- Regolazione auto flusso aria
- Super Cooling
- Riavvio 8°C
- I Feel
- Riscaldamento -15°C
- Funzione Sleep
- Funzione SMART

## PRATICITA'

- Controllo WiFi (opz.)
- Display LED
- Timer 24h
- Controllo cablato (opz)

## GARANZIA



3 anni prodotto +  
5 anni compressore

## BENESSERE

- 4 filtri in 1
- Antimuffa
- Filtro ai carboni

## EFFICIENZA

kW	Classe	65%
2,5	A++/A+	SI
3,5	A++/A+	SI
5,0	A++/A+	NO
7,0	A++/A+	NO





# ECO NEW EASY



**SOLO MONOSPLIT**

## COMFORT

- 19 dB(A)
- Super Cooling
- Riavvio 8°C
- I Feel
- Riscaldamento -15°C
- Funzione Sleep
- Funzione SMART

## PRATICITA'

- Display LED
- Timer 24h

## BENESSERE

- Antimuffa

## GARANZIA



3 anni prodotto +  
5 anni compressore

## EFFICIENZA

kW	Classe	65%
2,5	A++/A+	NO
3,5	A++/A+	NO
5,0	A++/A+	NO
7,0	A++/A+	NO



# CARATTERISTICHE



Silentium	<input type="radio"/>	<input type="radio"/>	<input type="radio"/>	
Energy	<input type="radio"/>	<input type="radio"/>	<input type="radio"/>	
New Comfort	<input type="radio"/>	<input type="radio"/>	Opt	<input type="radio"/>



Silentium	16	<input type="radio"/>	<input type="radio"/>	<input type="radio"/>	<input type="radio"/>	<input type="radio"/>	<input type="radio"/>	<input type="radio"/>	<input type="radio"/>	Opt	<input type="radio"/>	<input type="radio"/>
Energy	19	<input type="radio"/>	<input type="radio"/>	<input type="radio"/>	<input type="radio"/>	<input type="radio"/>	<input type="radio"/>	<input type="radio"/>	<input type="radio"/>	Opt	<input type="radio"/>	<input type="radio"/>
New Comfort	19	<input type="radio"/>	<input type="radio"/>	<input type="radio"/>	<input type="radio"/>	<input type="radio"/>	<input type="radio"/>	<input type="radio"/>	<input type="radio"/>	Opt	<input type="radio"/>	<input type="radio"/>











Silentium	<input type="radio"/>	<input type="radio"/>	<input type="radio"/>
Energy	<input type="radio"/>	<input type="radio"/>	<input type="radio"/>
New Comfort	<input type="radio"/>	<input type="radio"/>	<input type="radio"/>

# LINEA RESIDENZIALE MULTISPLIT



# UNITA' ESTERNE

					
4.2 kW	5.0 kW	7.0 kW	8.1 kW	10.5 kW	12.5 kW
Dual	Dual				
		 Trial			
			 Quadri	 Quadri	
					Penta







# UNITA' INTERNE



SERIE	2.0 kW	2.5 kW	3.5 kW	5.0 kW	7.0 kW
Silentium					
Energy					
New Comfort					
Cassetta			<b>NEW</b>	<b>NEW</b>	
Canalizzato		<b>NEW</b>	<b>NEW</b>	<b>NEW</b>	
Console		<b>NEW</b>	<b>NEW</b>	<b>NEW</b>	



## UNITA' INTERNE UNIVERSALI

Hisense

Confidential



# TABELLA COMBINAZIONI

	# INT	SILENTIUM		ENERGY				NEW COMFORT					CONSOLE			F/C	CANALIZZATO			CASSETTA 4 VIE	
		2.5	3.5	2.5	3.5	5.0	7.0	2.0	2.5	3.5	5.0	7.0	2.5	3.5	5.0	2.5	3.5	5.0	3.5	5.0	
ESTERNE																					
DUAL 4.2	2	✓	✓	✓	✓	✗	✗	✓	✓	✓	✗	✗	✓	✓	✗	✓	✓	✗	✓	✗	
DUAL 5.0	2	✓	✓	✓	✓	✗	✗	✓	✓	✓	✗	✗	✓	✓	✗	✓	✓	✗	✓	✗	
TRIAL 7.0	3	✓	✓	✓	✓	✓	✗	✓	✓	✓	✓	✗	✓	✓	✗	✓	✓	✗	✓	✗	
QUADRI 8.1	4	✓	✓	✓	✓	✓	✗	✓	✓	✓	✓	✗	✓	✓	✓	✓	✓	✓	✓	✓	
QUADRI 10.5	4	✓	✓	✓	✓	✓	✗	✓	✓	✓	✓	✗	✓	✓	✓	✓	✓	✓	✓	✓	
PENTA 12.3	5	✓	✓	✓	✓	✓	✓	✓	✓	✓	✓	✓	✓	✓	✓	✓	✓	✓	✓	✓	





**LINEA  
COMMERCIALE**





# UNITA' ESTERNE



2.6 kW	3.5 kW	5.0 kW	7.0 kW	10.5 kW	12.5 kW	14.0 kW	17.5 kW
<b>220V</b>	<b>220V</b>	<b>220V</b>	<b>220V</b>	<b>220V</b>	<b>380V</b>	<b>380V</b>	<b>380V</b>



2.6 kW	3.5 kW
<b>220V</b>	<b>220V</b>



**GAMMA COMPLETA IN R32  
NELLA SECONDA META' DEL 2018**



**Hisense**

Confidential



# UNITA' INTERNE



SERIE	2.6 kW	3.5 kW	5.2 kW	7.1 kW	9.0 kW	10.5 kW	12.5 kW	14.0 kW	17.5 kW
Cassetta		SINGLE FM	SINGLE FM	SINGLE TWIN	SINGLE	SINGLE TRIPLE	SINGLE	SINGLE TWIN TRIPLE Quadri	SINGLE TWIN TRIPLE
	Canalizzabile	SINGLE FM	SINGLE FM	SINGLE FM	SINGLE	SINGLE	SINGLE	SINGLE	SINGLE
	Soffitto/ Pavimento			SINGLE FM	SINGLE	SINGLE	SINGLE	SINGLE	SINGLE
	Console	SINGLE FM	SINGLE FM						





# SISTEMI PAC COMMERCIALI



## COMBINAZIONI

IDU		ODU			
		71	105	140	175
Cassette	35	TWIN	TRIPLE	QUADRI	
	52		TWIN	TRIPLE	TRIPLE
	71			TWIN	
	90				TWIN

## GIUNTI

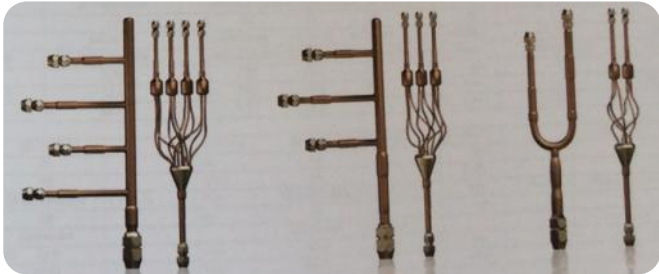

## SISTEMA

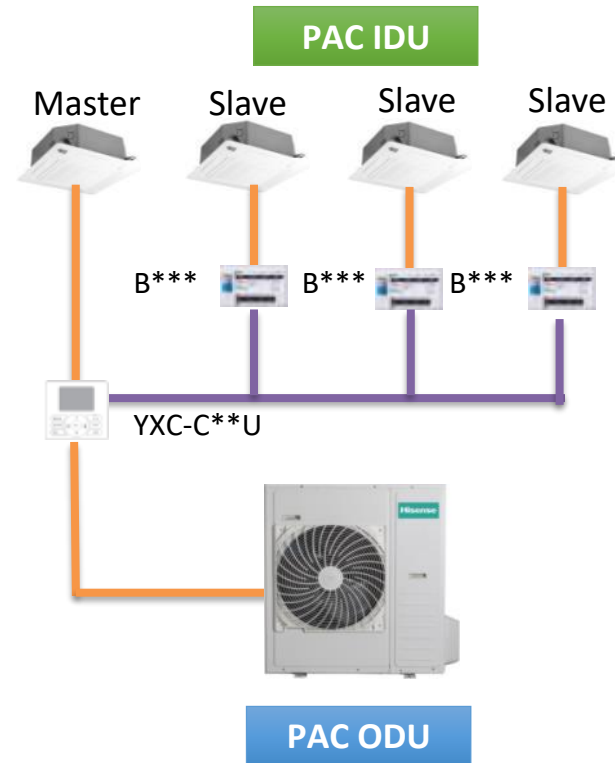

# SPECIFICHE TECNICHE

## SOFFITTO/PAVIMENTO

**DRAFT**

INTERNA	SEER Classe	SCOP Classe	EER	COP	Dimensioni In
AKT26UR4RK4	6,50/A++	4.02/A+	3,59	3,67	
AKT35UR4RK4	6,35/A++	4.10/A+	4,10	3,92	
AVT-52UR4SA3	6,80/A++	4,30/A+	3,02	3,24	990x680x230
AUV-71UR4SA3	6,11/A++	4,08/A+	3,23	3,46	990x680x230
AUV-105UR4SB3	6,11	4,11/A+	2,63	3,00	1285x680x230
AUV-125UR4SC3	6,11	4,01/A+	2,89	3,11	1580x680x230
AUV-140UR4SC3	6,11	4,02/A+	3,17	3,63	1580x680x230
AUV-175UR4C3	6,11	4,01/A+	3,28	3,73	1580x680x230

➔ Forniti con telecomando